



Large Systems Guide

Sample System

training@tigoenergy.com



Large Systems Guide

Sample System
Base Plan

Acme Widgets Site Map



Acme Widgets, Inc.
123 Sunnyside Blvd
Rancho Exceso, CA
93216

Equipment:

Solar Modules:
1408 x SuperSol 380W
with Tigo TS4-O

Inverters:
11 x Mega 50kW
4 MPPTs
2 strings per MPPT

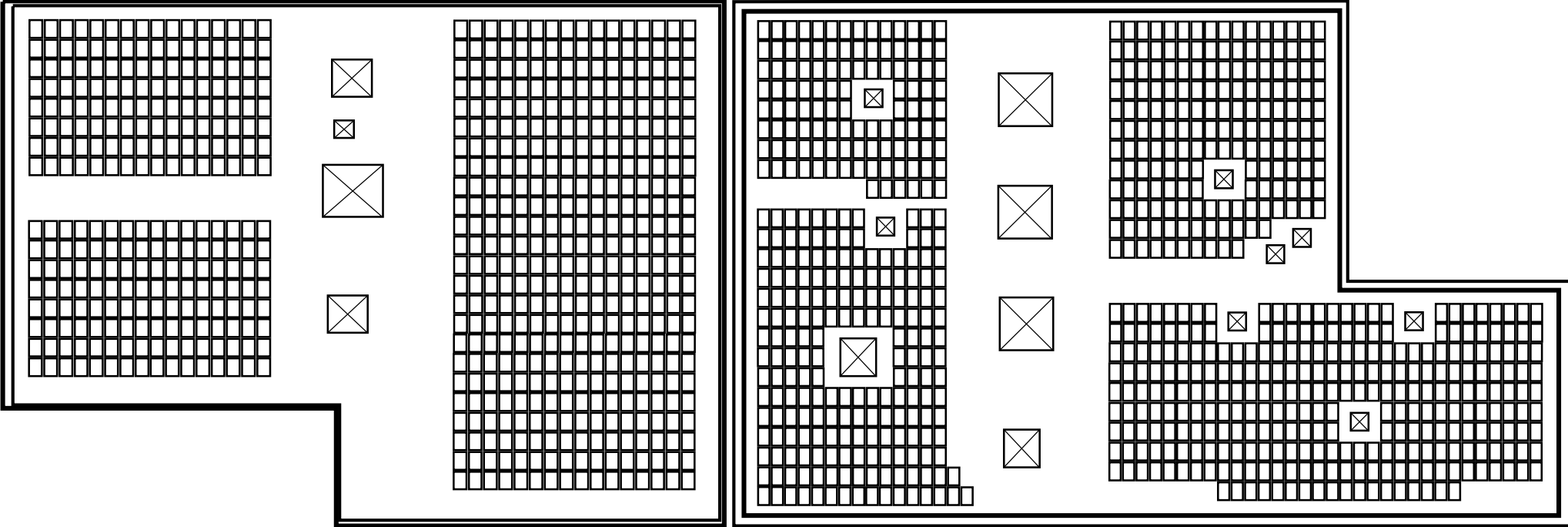

Section A
640 Modules

Section B
768 Modules



Large Systems Guide

Sample System
Section A

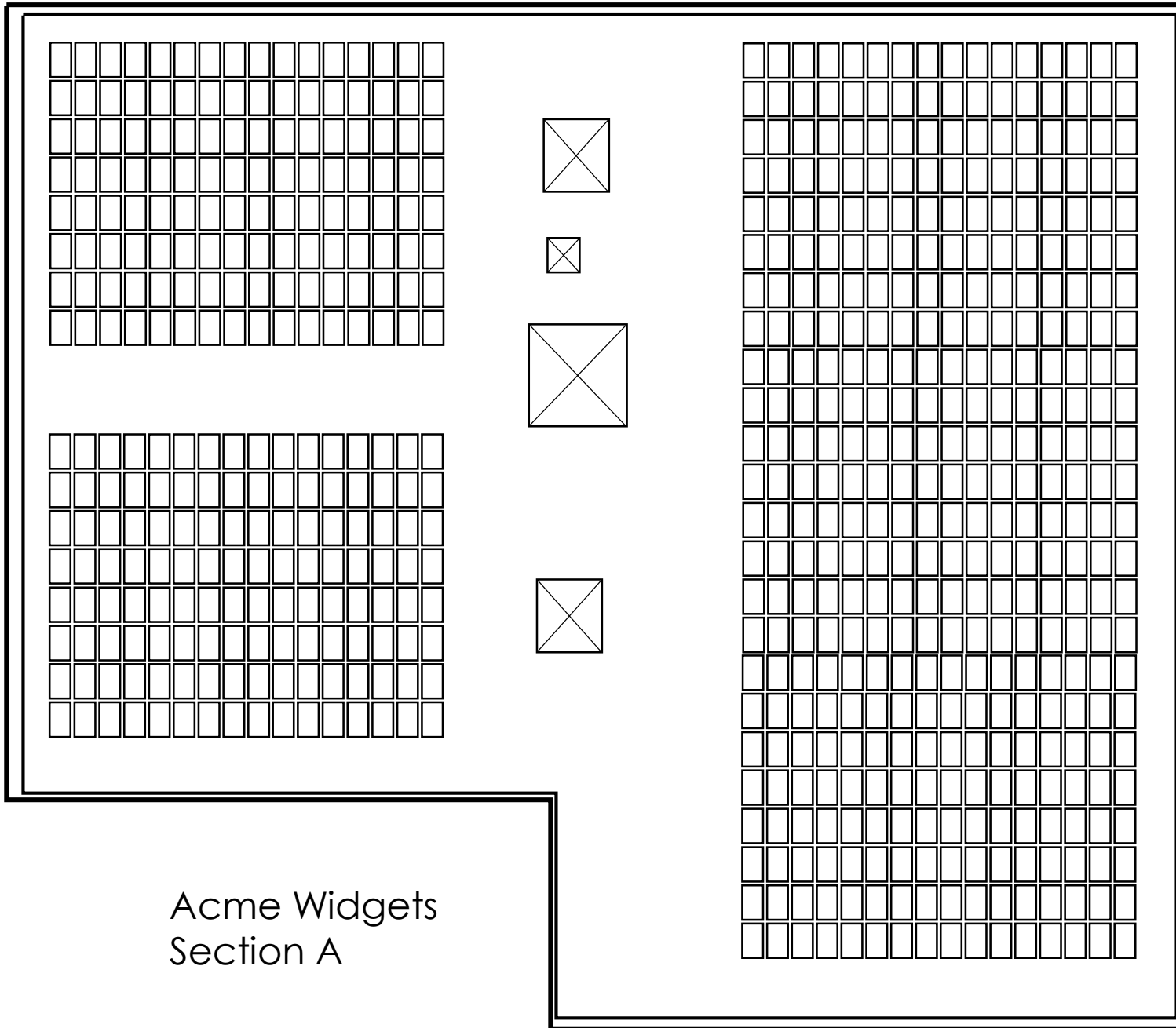

GENERAL NOTES:

These drawings show a sample single line diagram (SLD) and also how a Tigo communications layout is done.

The fictitious "Acme Widgets" site has a total of 1408 modules for 535 kWDC.

The first pages show "Section A".



Acme Widgets, Inc.
123 Sunnyside Blvd
Rancho Exceso, CA
93216

Equipment:

Solar Modules:
1408 x SuperSol 380W
with Tigo TS4-O

Inverters:
11 x Mega 50kW
4 MPPTs
2 strings per MPPT

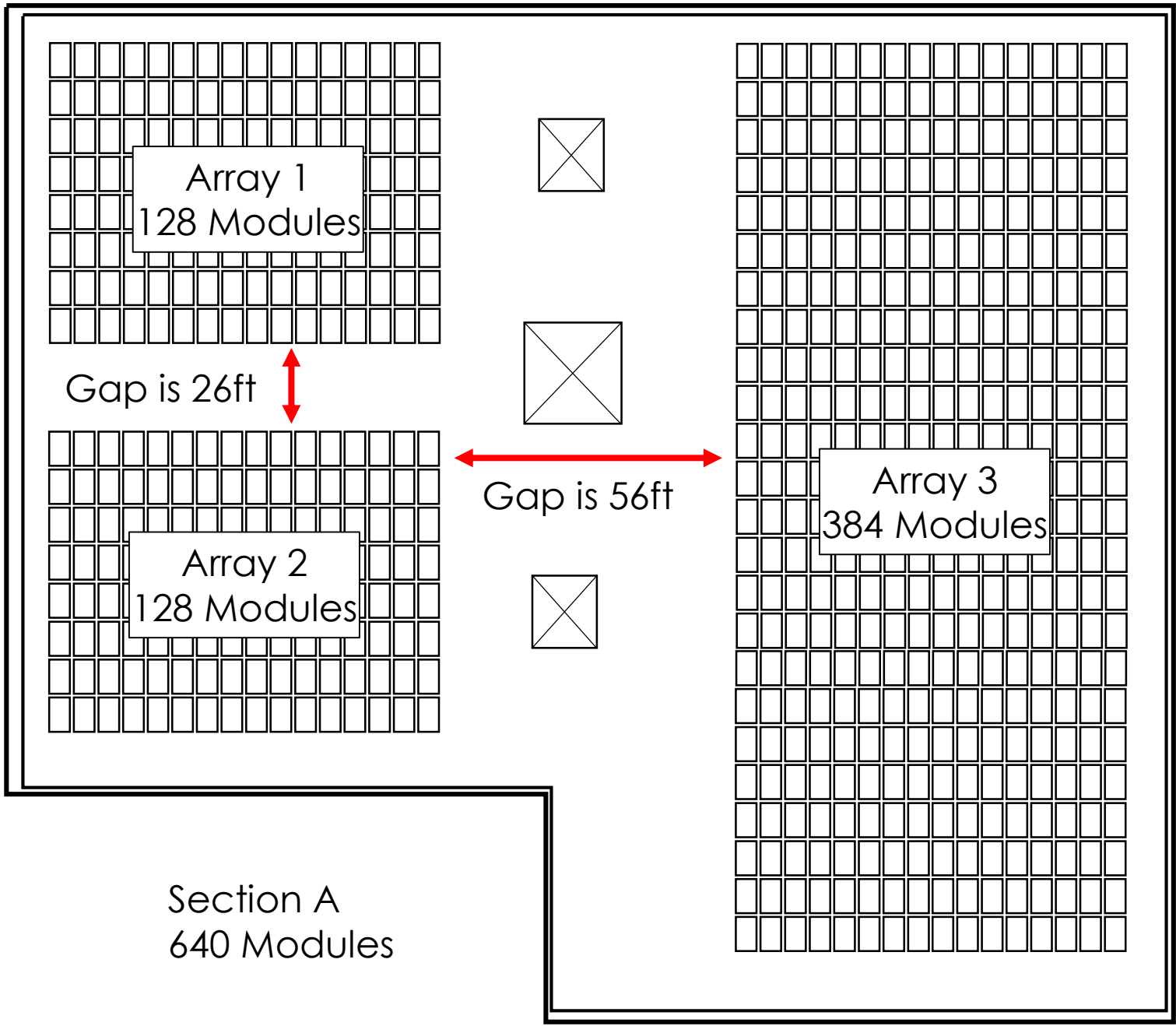

GENERAL NOTES:

Using Tigo's [Mesh wireless communications architecture](#), each TAP can support up to 300 TS4 units. Each CCA can support up to 900 TS4s.

With Mesh, each TS4 can act as a 'repeater' for the wireless communication signal. This way the signal can 'hop' from one TS4 to another. The maximum 'hop' distance is 33ft.

Since the gap between Array A and Array B is less than 33ft, the signal will be able to hop across this shorter gap; however the gap between Arrays 2 and 3 is 56ft, so the signal will not be able to hop across. An additional TAP will be needed (covered in the "CCA & TAP Layout" section of this document).



Acme Widgets, Inc.
123 Sunnyside Blvd
Rancho Exceso, CA
93216

- Equipment:
- Solar Modules:
1408 x SuperSol 380W
with Tigo TS4-O
 - Inverters:
11 x Mega 50kW
4 MPPTs
2 strings per MPPT

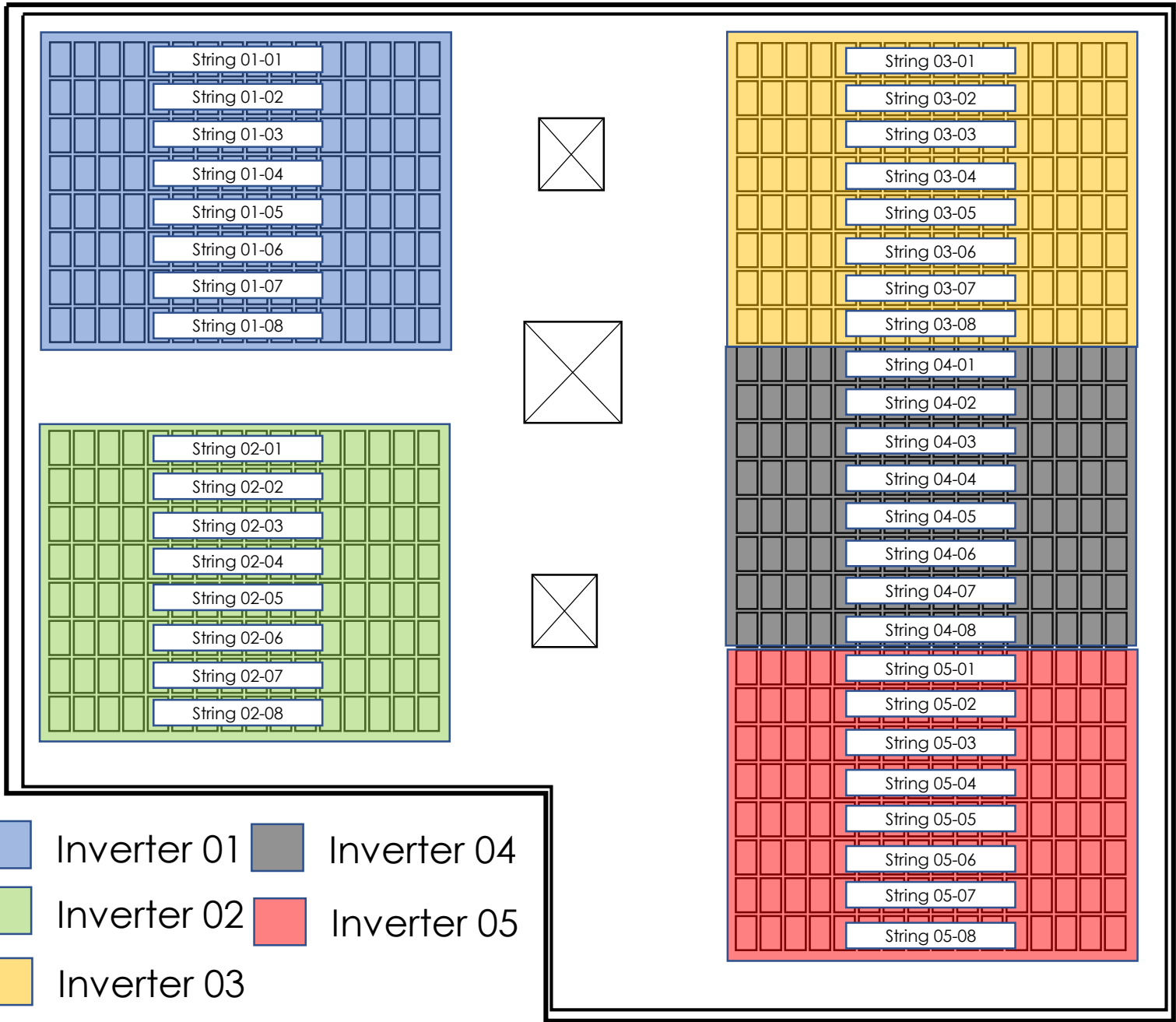

GENERAL NOTES:

Remember: assign all strings for any given inverter to the same CCA on your Tigo system. In other words, do not split a single string inverter across two CCA's.

For central inverters, a single inverter can be assigned to multiple CCA's, but do not assign strings from two different central inverters to the same CCA.

It is helpful to have a drawing like this one, showing the inverter assignment for all strings.

- Notice that:
- We have 8 strings per inverter, 2 strings per MPPT, 4 MPPTs for each inverter
 - Each string is assigned to an inverter



Acme Widgets, Inc.
123 Sunnyside Blvd
Rancho Exceso, CA
93216

Equipment:

Solar Modules:
1408 x SuperSol 380W
with Tigo TS4-O

Inverters:
11 x Mega 50kW
4 MPPTs
2 strings per MPPT



Large Systems Guide

Sample System
Section B

Acme Widgets, Inc.
123 Sunnyside Blvd
Rancho Exceso, CA
93216

Equipment:

Solar Modules:
1408 x SuperSol 380W
with Tigo TS4-O

Inverters:
11 x Mega 50kW
4 MPPTs
2 strings per MPPT

GENERAL NOTES:

Section B has 768 modules.

Section B

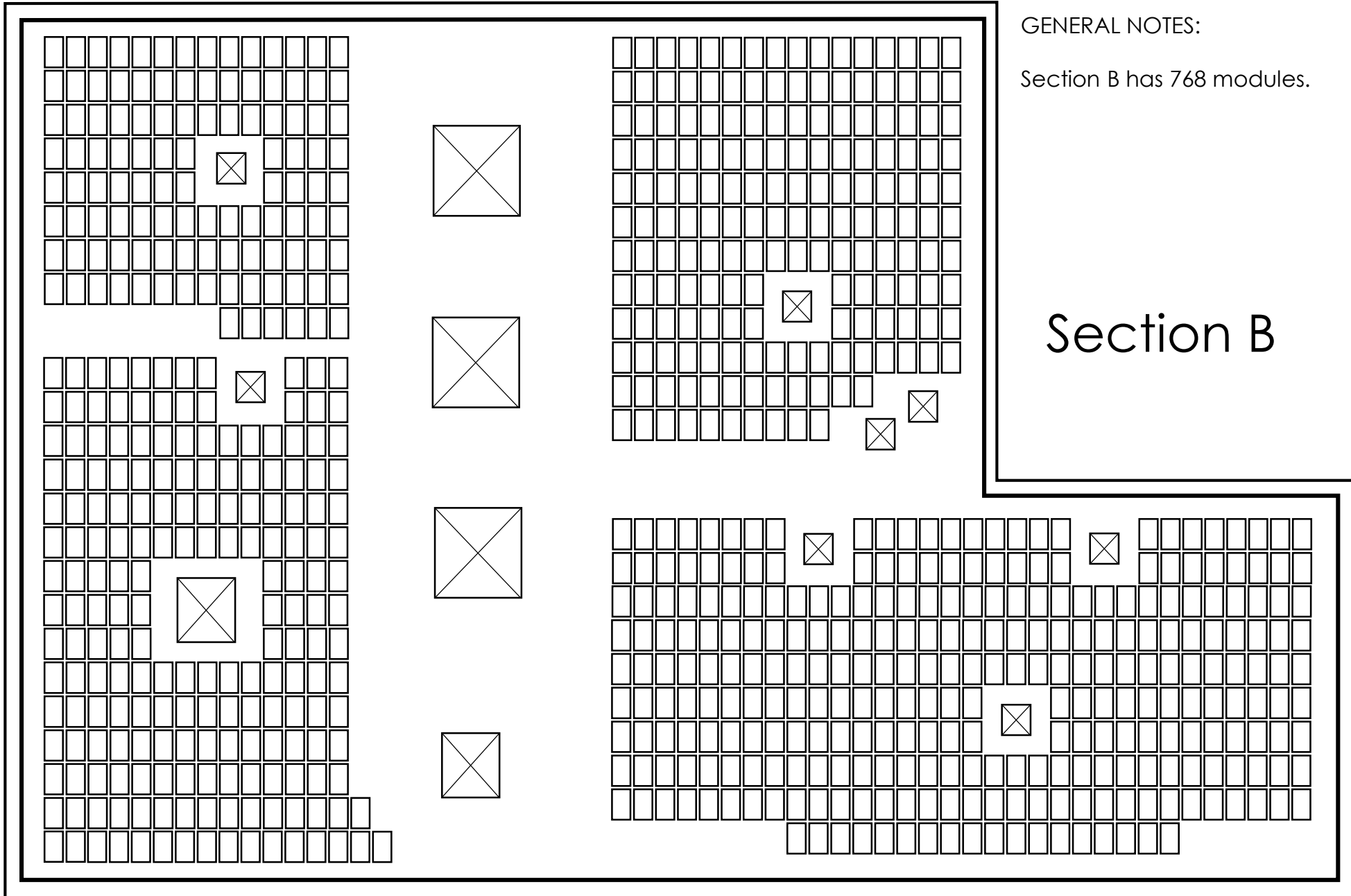

Equipment:

Solar Modules:
1408 x SuperSol 380W
with Tigo TS4-O

Inverters:
11 x Mega 50kW
4 MPPTs
2 strings per MPPT

GENERAL NOTES:

Like Section A, Section B has a gap in the middle that is more than 33ft, so the design will have TAPs on both sides of the gap.

Section B Arrays

768 Modules Total

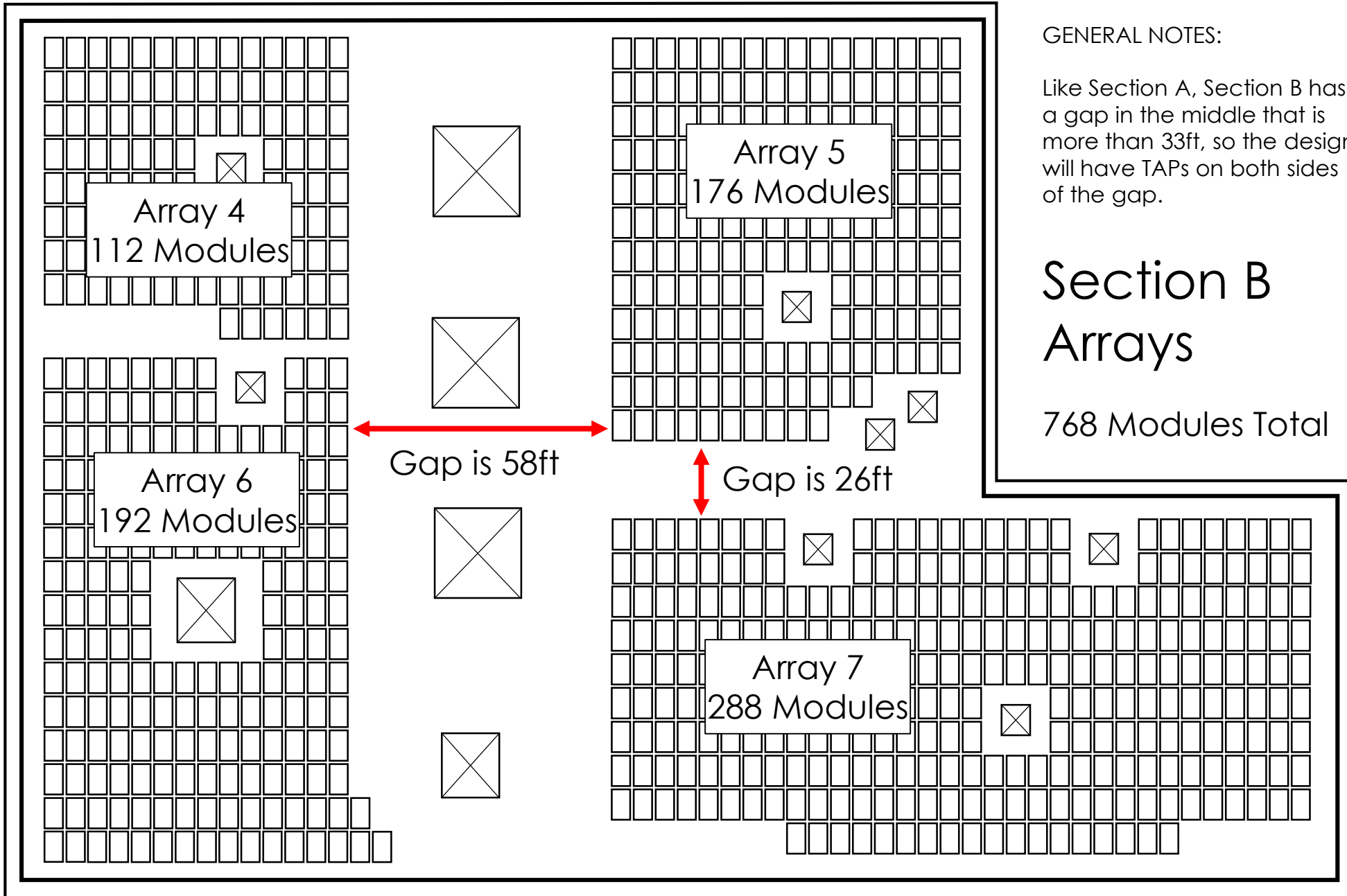

Equipment:

Solar Modules:
1408 x SuperSol 380W
with Tigo TS4-O

Inverters:
11 x Mega 50kW
4 MPPTs
2 strings per MPPT

GENERAL NOTES:

The string layout for Section B is more complicated due to obstructions.

Section B String Layout

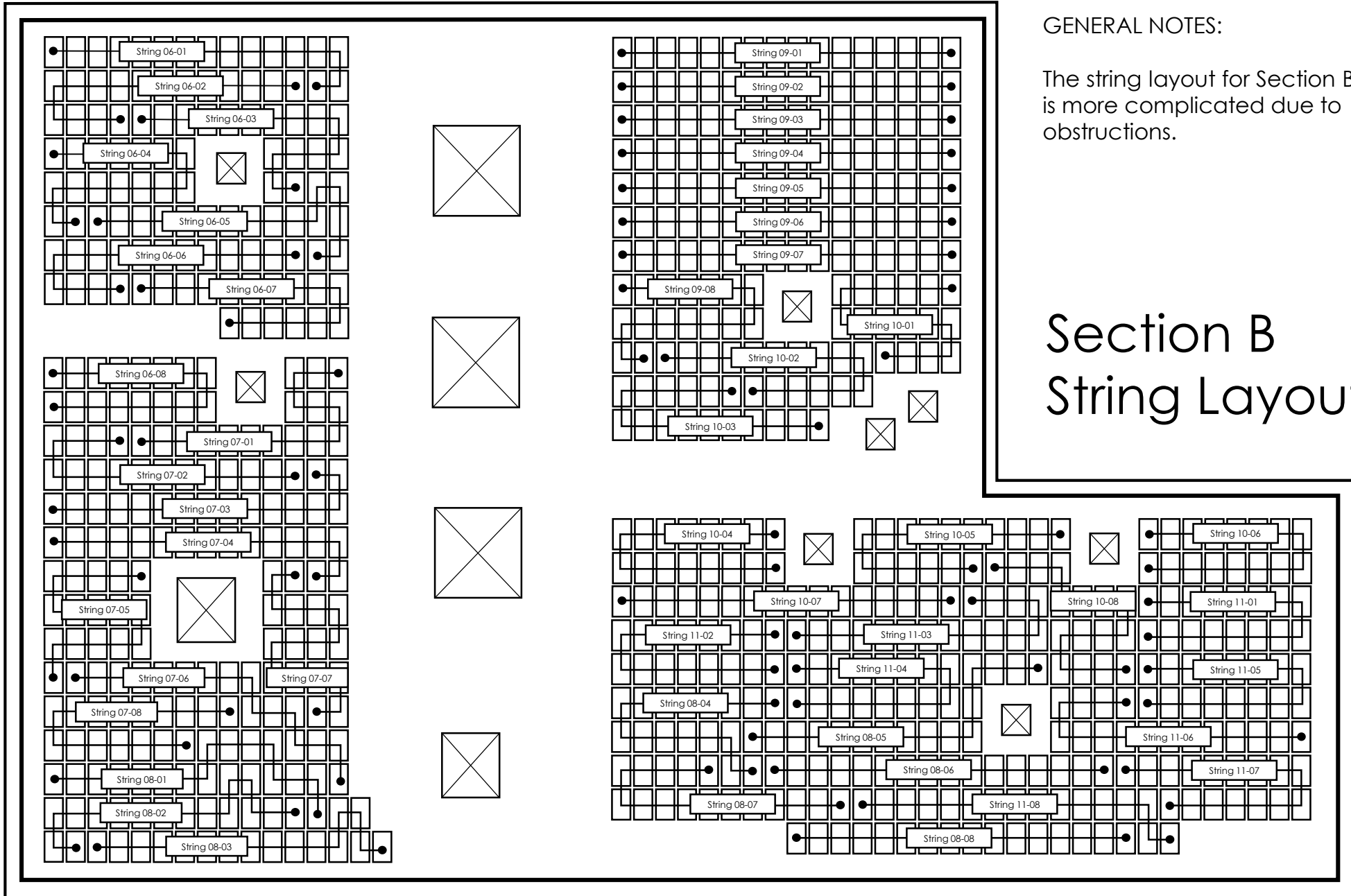

Acme Widgets, Inc.
123 Sunnyside Blvd
Rancho Exceso, CA
93216

Equipment:

Solar Modules:
1408 x SuperSol 380W
with Tigo TS4-O

Inverters:
11 x Mega 50kW
4 MPPTs
2 strings per MPPT

Acme
Widgets
Section
B

- Inverter 06
- Inverter 07
- Inverter 08
- Inverter 09
- Inverter 10
- Inverter 11

Section B Inverter Layout

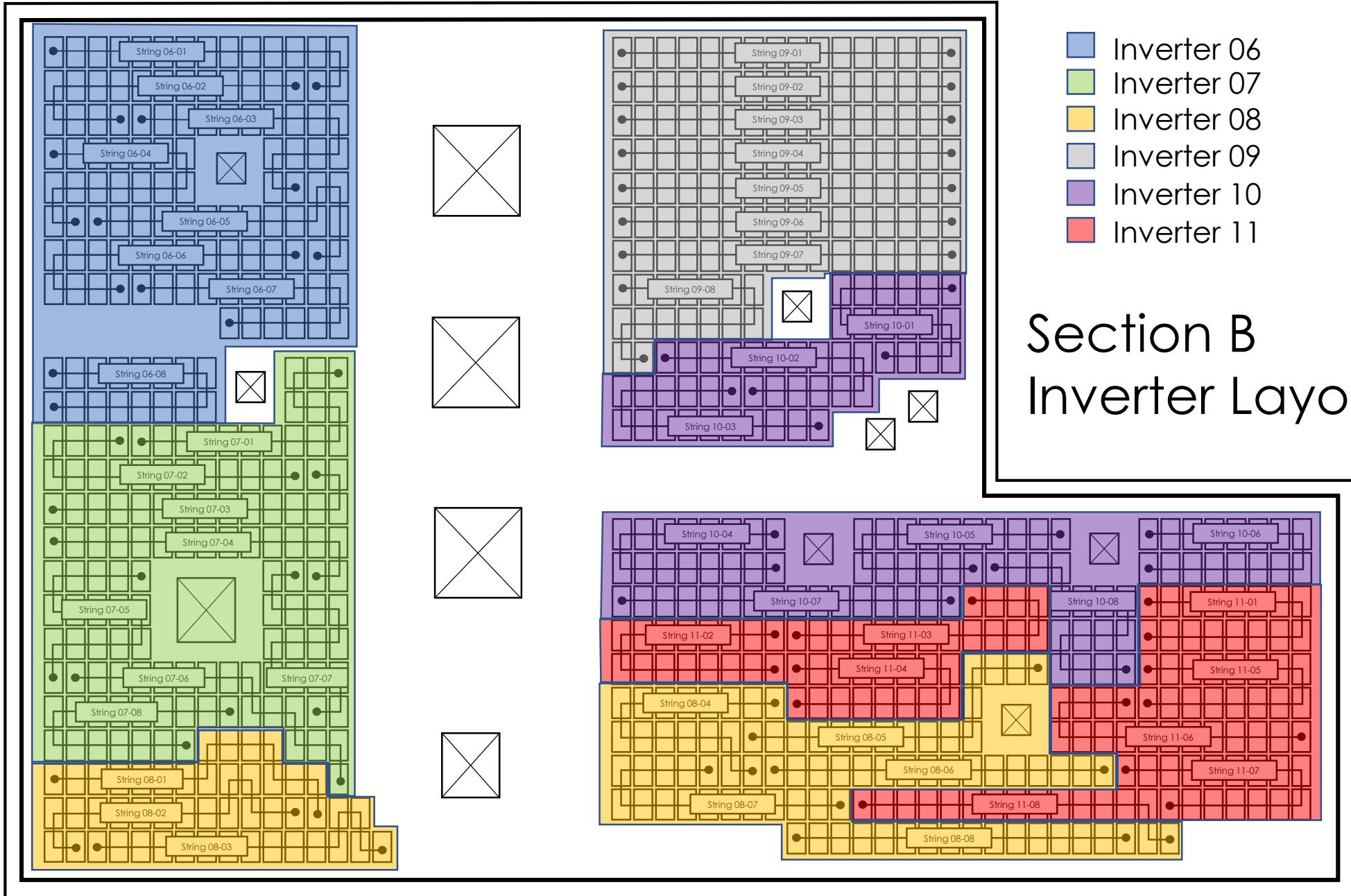



Large Systems Guide

Sample System
CCA & TAP Layout

CCA & TAP Rules

- Up to 300 TS4s per TAP
- Up to 7 TAPs per CCA
- Up to 900 TS4s per CCA
- Minimum distance between TAPs: 15m/50ft
- Maximum distance from TAP to farthest TS4: 35m/115ft
- Maximum hop distance TS4 -> TS4: 10m/33ft
- Do not split any string across more than one CCA
- Do not split any string inverter across more than one CCA

Acme Widgets CCA Layout

General Notes: Sections A and B are both less than 900 TS4s, so each can be served with one CCA



Acme Widgets, Inc.
123 Sunnyside Blvd
Rancho Exceso, CA
93216

Equipment:

Solar Modules:
1408 x SuperSol 380W
with Tigo TS4-O

Inverters:
11 x Mega 50kW
4 MPPTs
2 strings per MPPT

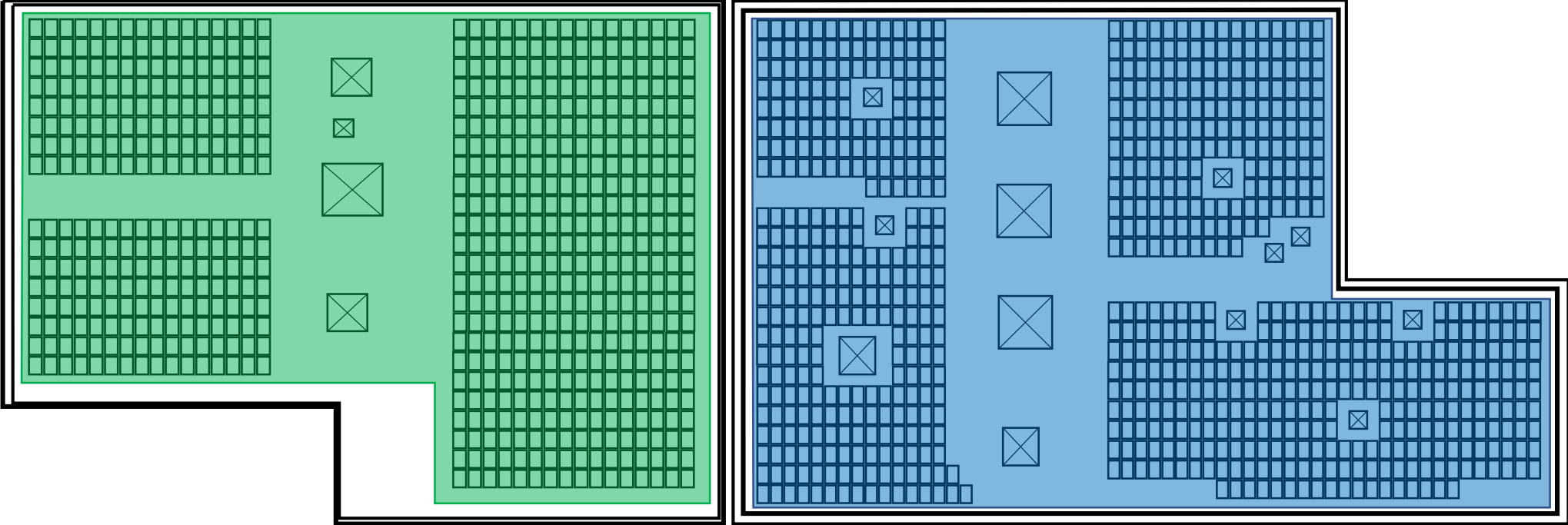

Section A – 640 Modules
CCA01

Section B – 768 Modules
CCA02

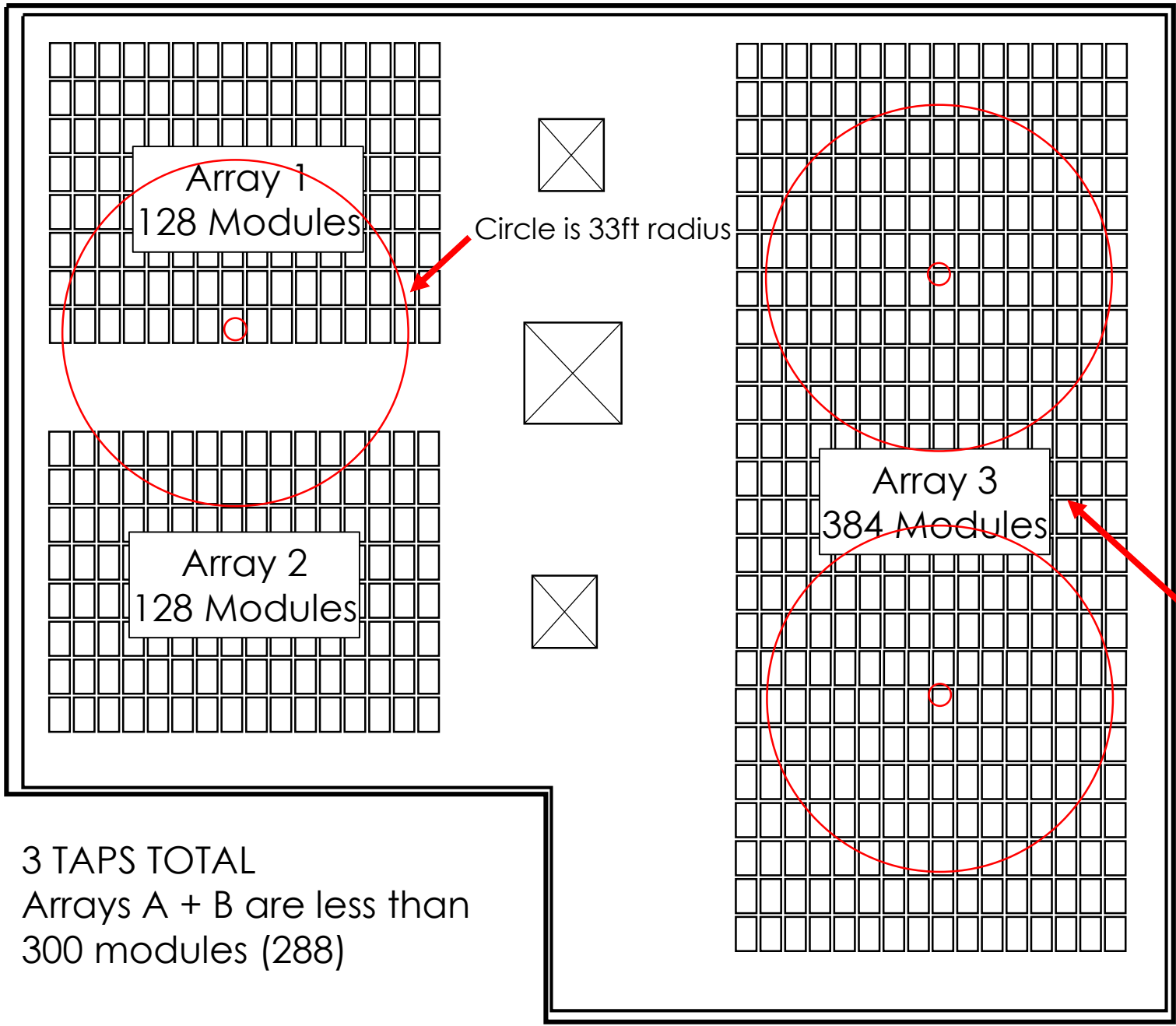

GENERAL NOTES:

Since the gap between Array 1 and Array 2 is less than 33 ft (10m), only one TAP is used for Arrays 1 and 2.

Section A TAP Layout

Arrays 3 is more than 300 modules (384), so 2 TAPs are needed here

Always mount TAPs in a central location to the modules with which they communicate



Acme Widgets, Inc.
123 Sunnyside Blvd
Rancho Exceso, CA
93216

Equipment:

Solar Modules:
1408 x SuperSol 380W
with Tigo TS4-O

Inverters:
11 x Mega 50kW
4 MPPTs
2 strings per MPPT

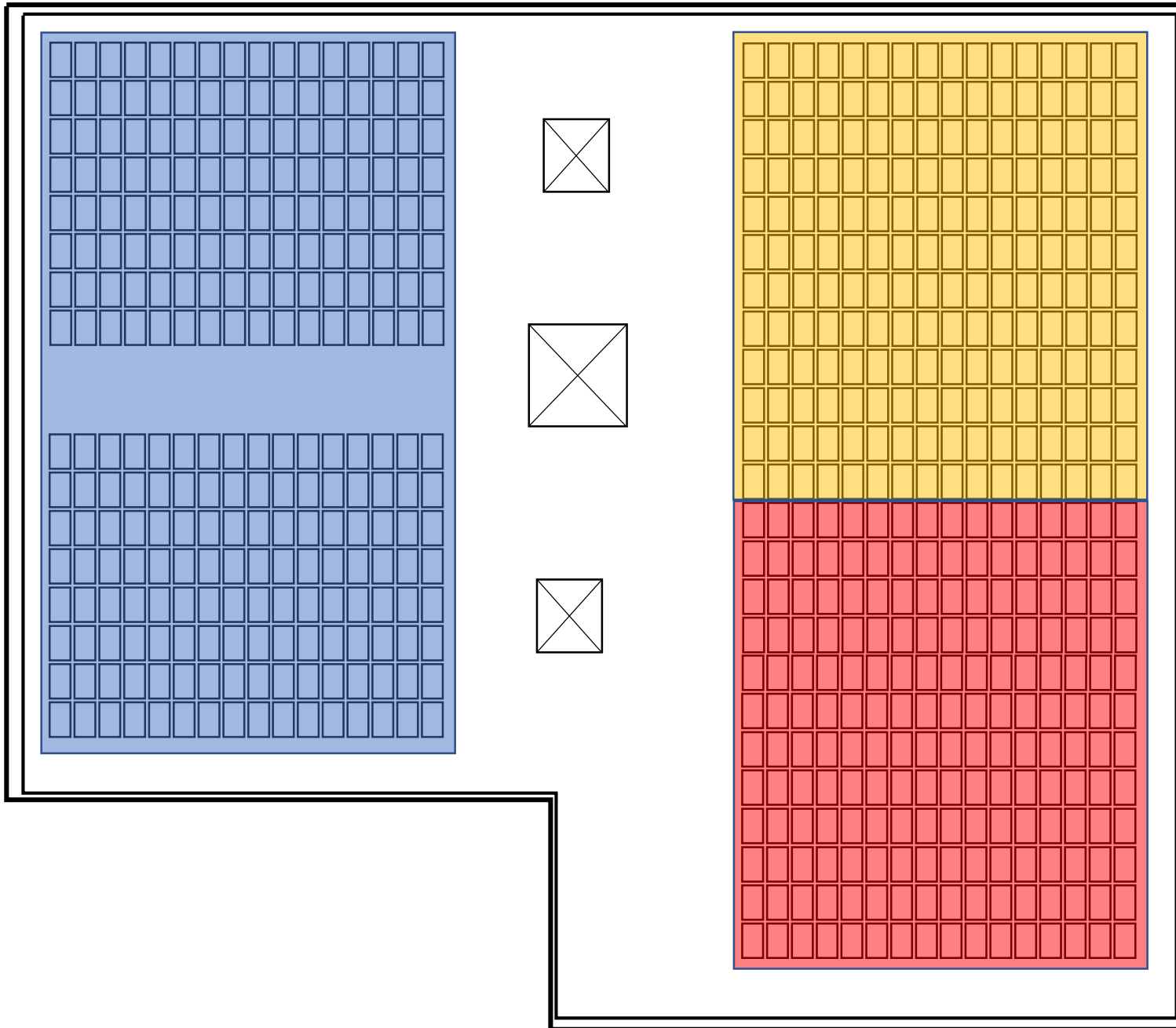

GENERAL NOTES:

Section A TAP Layout

- TAP 01, CCA 01
- TAP 02, CCA 01
- TAP 03, CCA 01



Acme Widgets, Inc.
123 Sunnyside Blvd
Rancho Exceso, CA
93216

Equipment:

Solar Modules:
1408 x SuperSol 380W
with Tigo TS4-O

Inverters:
11 x Mega 50kW
4 MPPTs
2 strings per MPPT

Equipment:

Solar Modules:
1408 x SuperSol 380W
with Tigo TS4-O

Inverters:
11 x Mega 50kW
4 MPPTs
2 strings per MPPT

GENERAL NOTES:

These drawings show a sample single line diagram (SLD) and also how a Tigo communications layout is done.

Section B TAP Layout

4 TAPs

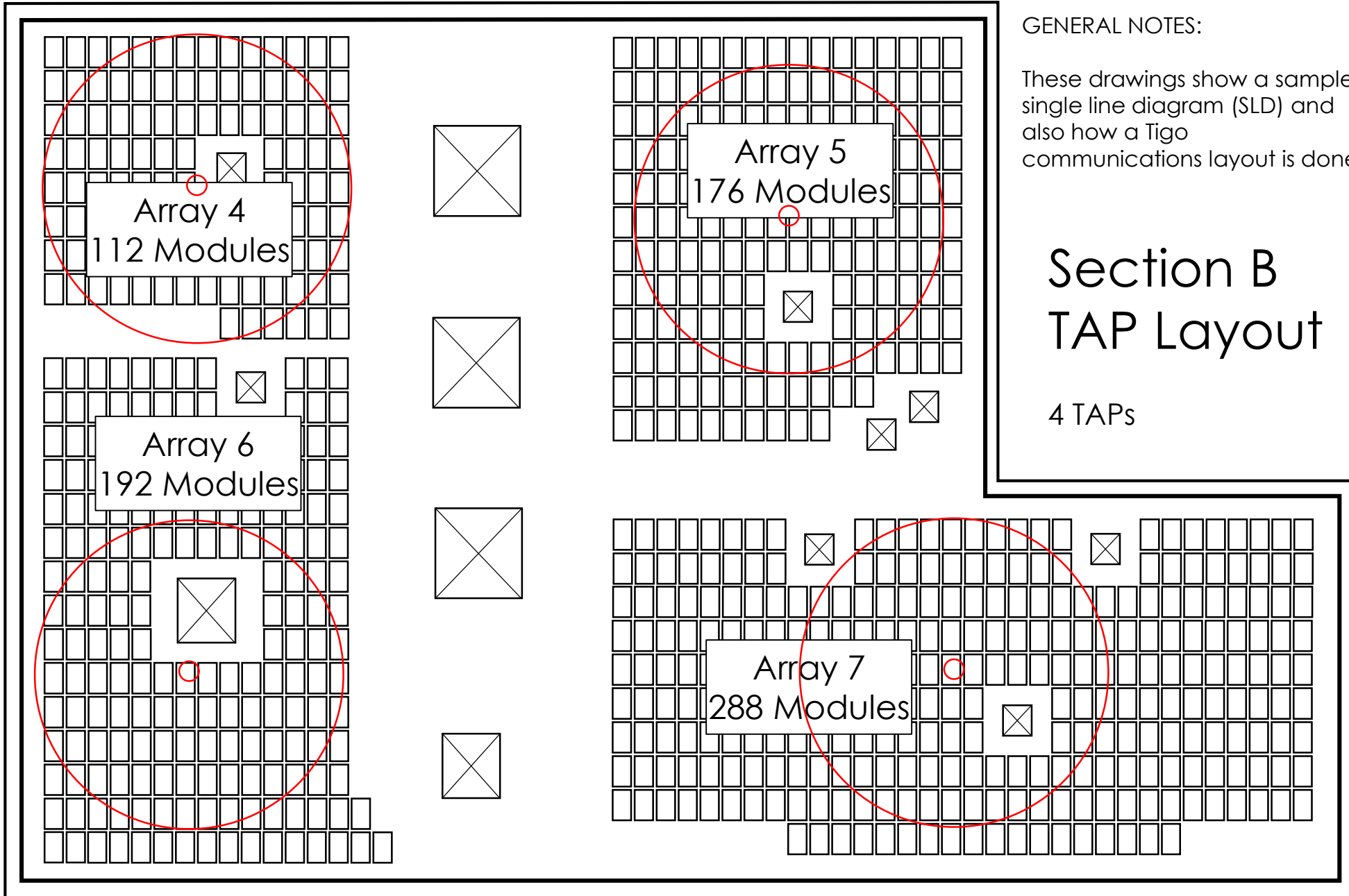





Equipment:

Solar Modules:
1408 x SuperSol 380W
with Tigo TS4-O

Inverters:
11 x Mega 50kW
4 MPPTs
2 strings per MPPT

Section B TAP Layout

-  TAP 04, CCA 02
-  TAP 05, CCA 02
-  TAP 06, CCA 02
-  TAP 07, CCA 02

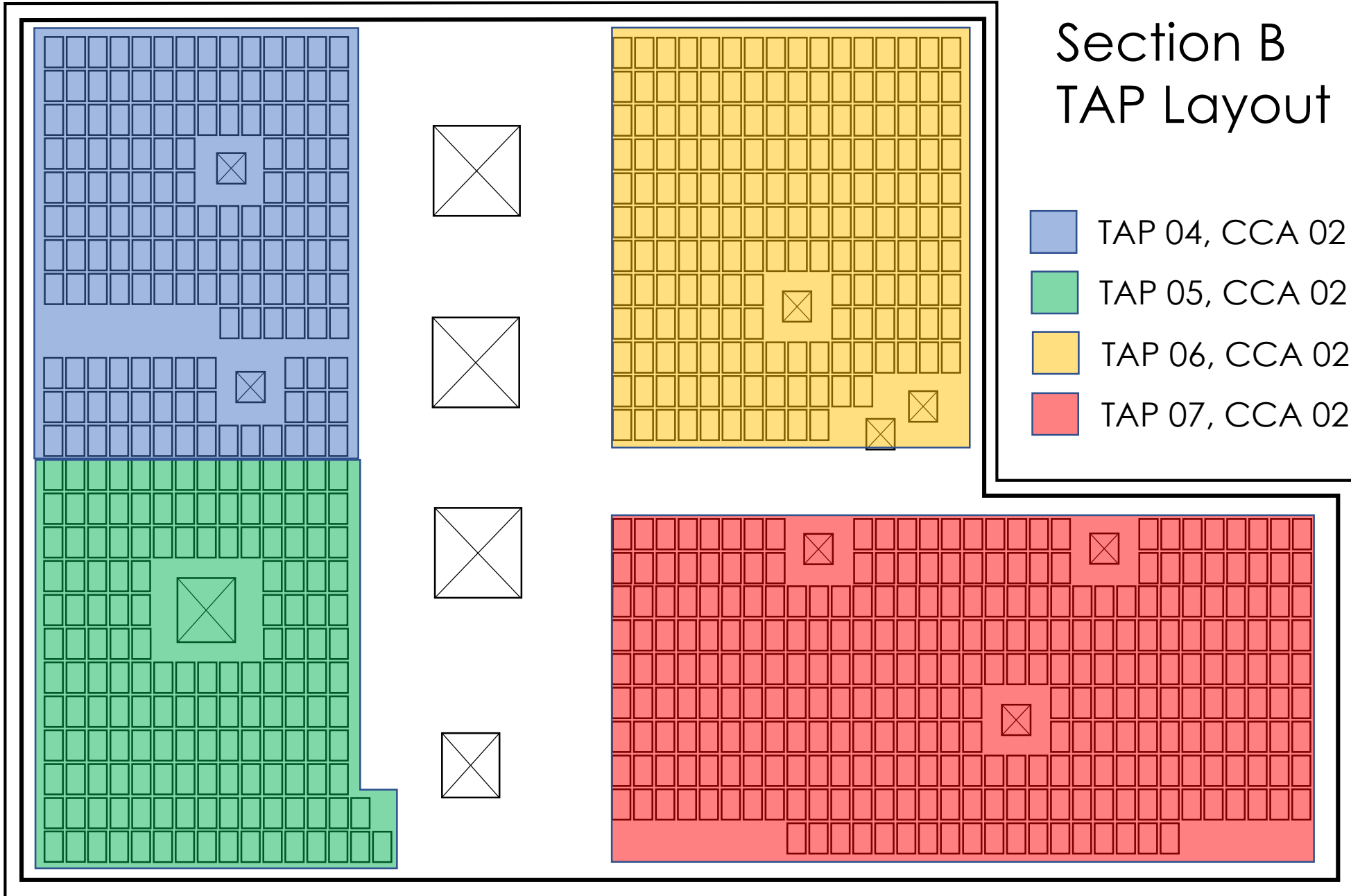

Bill of Materials (BOM)

Quantity	Item
1408	Tigo TS4 -M, -S, -O, or -L
2	Cloud Connect Advanced (CCA)
7	Tigo Access Point (TAP)

Needed to complete:

- Power supplies and enclosures for the CCAs
- Cable (with conduit) to connect the CCAs to the TAPs

Design Review

- Double check all counts and ranges carefully
- Have a colleague check your work
- Send your design to us: training@tigoenergy.com for review



Large Systems Guide

Sample System
Single Line Diagrams

Equipment:

Solar Modules:
1408 x SuperSol 380W
with Tigo TS4-O

Inverters:
11 x Mega 50kW
4 MPPTs
2 strings per MPPT

Single Line Diagram

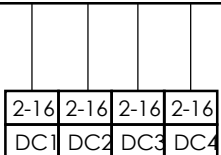
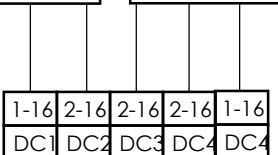
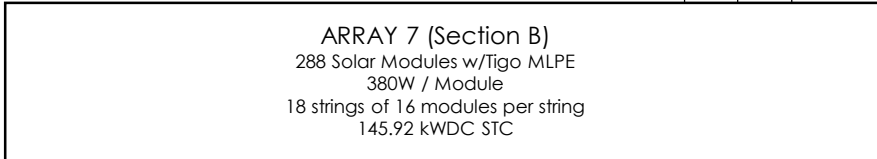
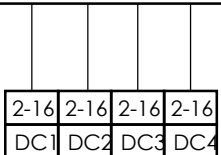
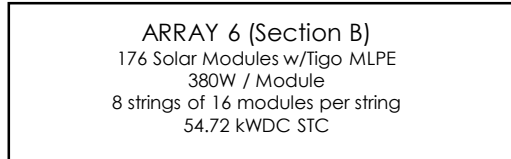
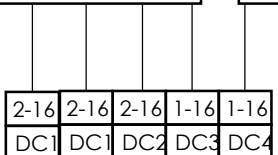
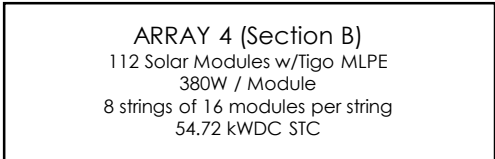
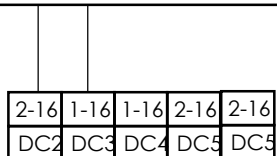
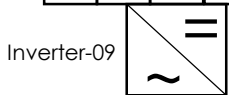
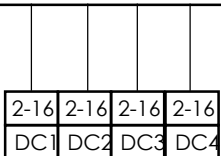
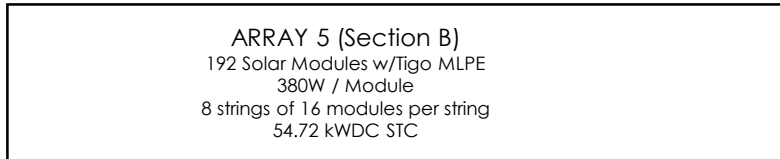
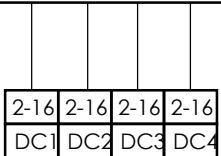
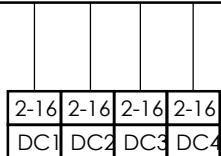
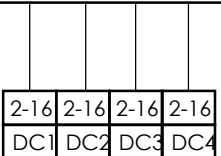
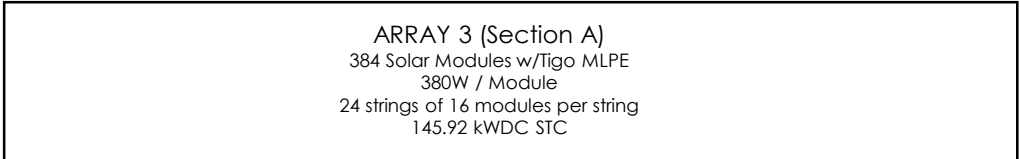
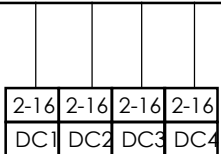
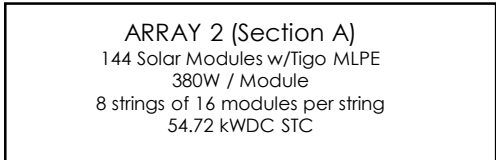
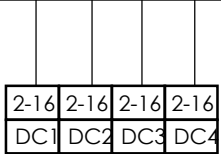
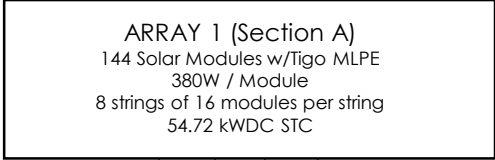

Single Line Diagram

GENERAL NOTES:

This page shows a sample single line diagram (SLD) representation of the Tigo system.



Acme Widgets, Inc.
123 Sunnyside Blvd
Rancho Exceso, CA
93216

Equipment:

Solar Modules:
1408 x SuperSol 380W
with Tigo TS4-O

Inverters:
11 x Mega 50kW
4 MPPTs
2 strings per MPPT

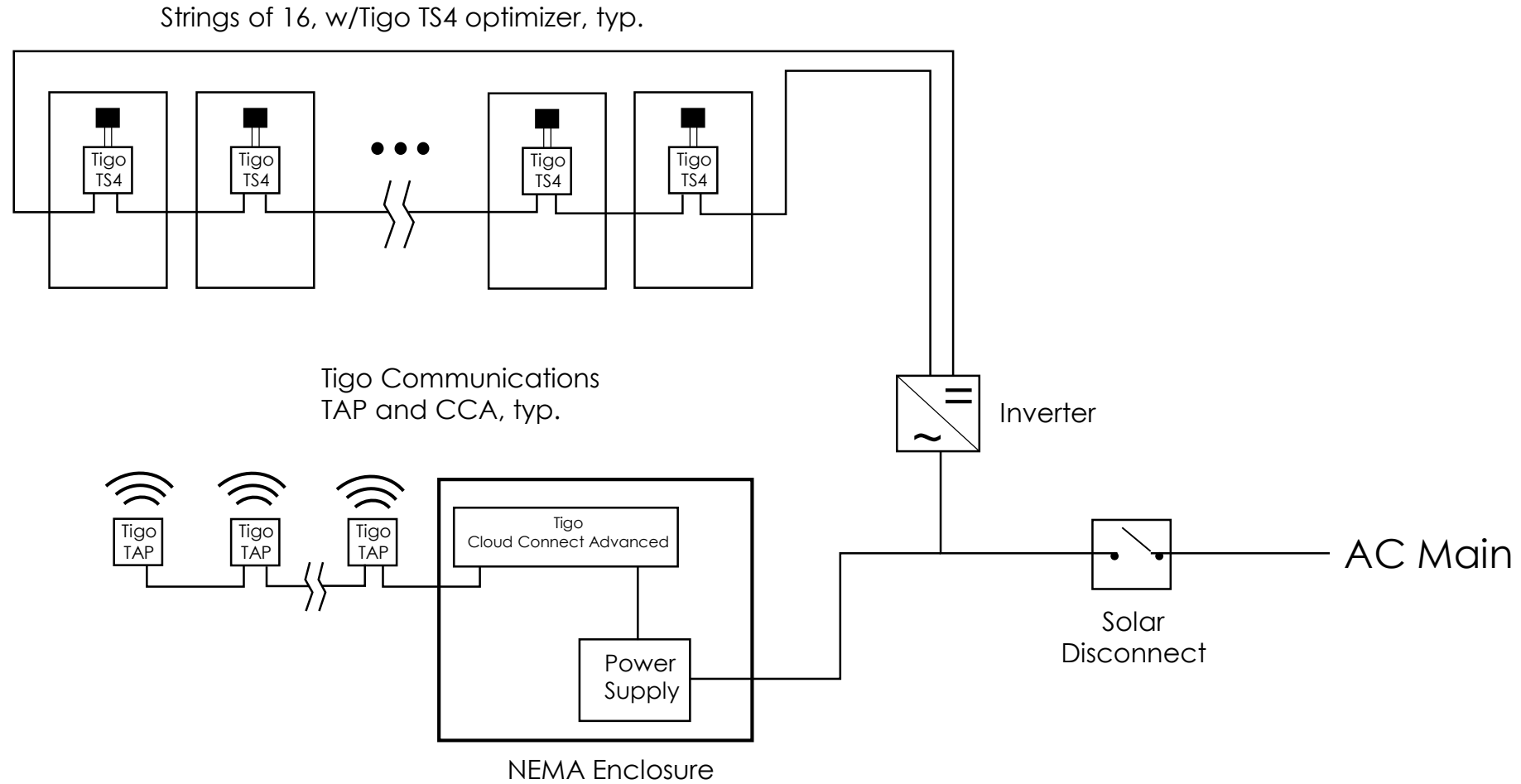

avec vous

あなたと

איתך

与你

mit dir

Tigo[®]

당신과 함께

is with you

esta contigo

معك

met jou

con te

Thank you!

sales@tigoenergy.com

Technical Questions? training@tigoenergy.com

More Info: support.tigoenergy.com